





# SIRIO 1

Porta attrezzi frontale singolo a regolazioni meccaniche  
 Front single frame with mechanical adjustment  
 Cadre porte-outils frontal simple  
 Einseitiger frontaler geräteträger

Dimensioni di lavoro | Working width  
 Taille de travail | Arbeitsgröße

MOD. SIRIO 1	 MIN cm	
	85	150
	130	140
	L. 25 cm	105
	L. 50 cm	110
	L. 65 cm	115





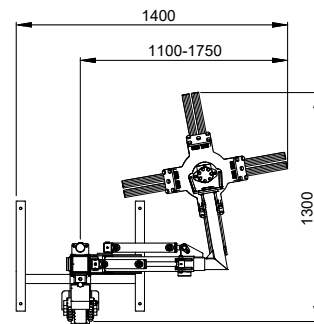

Regolatore di flusso  
 Flux regulator  
 Régulateur de flux  
 Flussregler  
**NON PER** - Not for - Pas pour - Nicht für  
 COD. 104104L - 104104J



COD.	Movimenti - Movements - Mouvements - Bewegungen	Levers	Joystick	Distributore	Oil - Pressure
<b>104100M</b>		+ ON/OFF MOTOR			20 l/min 180 bar max
<b>104101I</b>		+ ON/OFF MOTOR			25 l/min 180 bar max
<b>104102I</b>		+ ON/OFF MOTOR			25 l/min 180 bar max
<b>104103I</b>		+ ON/OFF MOTOR			25 l/min 180 bar max
<b>104104L</b>		+ ON/OFF MOTOR			30 l/min 180 bar max
<b>104104J</b>		+ ON/OFF MOTOR			30 l/min 180 bar max

## ATTREZZI PER SIRIO 1 - TOOLS FOR SIRIO 1 - OUTILS POUR SIRIO 1 - ZUBEHÖR FÜR SIRIO 1

ATTREZZI	Descrizione - Description - Description - Beschreibung		
<b>1U41300</b>	Spollonatore - Shoot removing head Empampreuse - Rebstammputzer		
<b>1U41100</b>	Girorami per vigneto - Pruning rake for vineyards Andaineur pour vignoble - Kehrbesen für weinberge		
<b>1U41200</b>	Girorami per frutteto - Pruning rake for orchard Andaineur pour verger - Kehrbesen für obstplantagen		
<b>1U41400</b>	Campana diserbo chimico - Chemical weeding bell Tête herbicide - Chemische Unkrautglocke	L. = 25 cm	
<b>1U41500</b>	Campana diserbo chimico - Chemical weeding bell Tête herbicide - Chemische Unkrautglocke	L. = 50 cm	
<b>1U41600</b>	Campana diserbo chimico - Chemical weeding bell Tête herbicide - Chemische Unkrautglocke	L. = 65 cm	
OPTIONAL	Descrizione - Description - Description - Beschreibung		
<b>1A422095</b>	Kit Box H2O con elettrovalvola - Kit Box H2O with electro valve - Kit H2O Box avec électrovanne - H2O Box Kit mit Magnetventil		
<b>1A0350300</b>	Valvola regolatrice di flusso - Flow valve regulation - Régulateur de flux - Durchflussregelventil		
<b>1A32040</b>	Piastra attacco rapido femmina - Female quickly connection - Plaque d'accouplement rapide femelle - Weibliche Schnellkupplungsplatte		
<b>1A32051</b>	Staffa fissa maschio grezza - Male quickly connection - Support fixe mâle - Rohe männliche feste Halterung		
<b>1A32050</b>	Staffa fissa al trattore (fornire modello e tipo di trattore) - Male connection for tractor (type and version of tractor) Support fixé au tracteur (indiquez le modèle et le type de tracteur) - Am Traktor befestigte Halterung (Modell und Typ des Traktors angeben)		
<b>1A32060</b>	Attacco a tre punti fisso - Fix three point linkage - Attelage trois points fixe - Dreipunktaufhängung behoben		
<b>1A32070</b>	Attacco a tre punti con aggancio rapido per sollevatore - Three point attachment with quick coupling for lift Attelage trois points avec connexion pour relevage à l'avant - Dreipunktaufhängung mit Schnellkupplung für Lifter		